



# IT Infrastructure

Modern energy management thanks to intelligent PDUs.

**BluNet**

**BACH  
MANN**  
We power your life.

WE  
**power**  
YOUR LIFE.



Our goal here at BACHMANN is to be a trendsetter and to bring innovations to life. We want to improve Life Quality with our solutions – people should feel at ease with our technology.

**Peter Bachmann | CEO**

# Contents

## 06 Your advantages with BACHMANN PDUs

Tested BlueNet quality	08
.....	
Regular electrical testing in accordance with international standards	10
.....	
A variety of plugs for international use	12
.....	
Customising with the BACHMANN modular principle	14

## 16 BACHMANN PDU portfolio

### **IT BASIC SERIES**

IT PDU Basic 1U 19"	18
IT PDU Basic 1U vertical	20
.....	

### **BlueNet series**

BlueNet – smart solutions	22
BlueNet overview	24

## 26 Technology modules

Overview and benefits	28
-----------------------	----

---

### **High quality electrical engineering**

- Neutral conductor monitoring	34
- Type B residual current monitoring (RCM)	36
- Surge protection device (SPD)	38
- Colour coding	40
- Powerline Communication (PLC)	42
- Innovation: 380VDC PDUs	44

---

### **PDUs: the central information and control element in the rack**

- Energy monitoring and management	46
- Monitoring with BlueNet software	48
- Cascading using the master-slave concept	50
- GPIO Module	52
- BlueNet sensors	54

## 56 The BACHMANN Group

We are a partner you can rely on when it comes to all aspects of power supply for data centres. For over 70 years now, we have been specialising not only in desk connection panels for the office, home and hotels, but also in high-quality power distribution units whose smart functions give you a great deal of added value.

**Your advantages with  
BACHMANN PDUs**



Tested BlueNet quality



Regular electrical  
testing in accordance  
with international standards



A variety of plugs for  
international use



Customising with the  
BACHMANN modular principle

# Tested BlueNet quality

## Guaranteeing reliability

Before our BlueNet PDUs reach you, we make sure that they meet our high quality standards. Every BACHMANN PDU is tested and documented as early as the production stage, using a computer-based test programme. Electronic components are continually subjected to “stress tests” to guarantee consistent quality. BlueNet is therefore integrated into compact, very robust yet weight-optimised aluminium housings.

The requirements of the relevant standards and guidelines are not only fulfilled, the majority are even surpassed. It is incredibly important to us that our products are reliable.

We also provide you with a number of services specifically tailored to BlueNet PDUs: the BACHMANN service team ensures that your products deliver the best they can at all times.

With our services, we ensure that you can operate your BlueNet PDUs optimally.





**BluNet**

# Regular electrical testing in accordance with international standards

## Complying with the law without switching off

EN 50110-1 provides a normative basis for regulating the operation of an electrical system and, consequently, a data centre. This standard, require electrical retests to be carried out every four years. A crucial partial test is the insulation measurement, which must be performed in a de-energised state, i.e. the electrical system and, therefore, the data centre must be switched off.

However, since a data centre has to provide high availability and so simply cannot be switched off, our RCM technology makes use of an exemption clause contained in the EN 50110-1 standard. This clause indicates, amongst other things, that an insulation test is not required, and so switch-off does not have to occur, if an electrical system is overseen by specialist personnel and continuously monitored using measuring instruments.

The measurement reports of the BACHMANN residual current monitoring (RCM) can be submitted during a retest as proof of the level of insulation. The other partial tests required can be conducted when the system is live, i.e. without having to switch off the data centre.

Our BlueNet PDUs with integrated residual current monitoring provide you with granulated measurement results and tell you about the tiniest changes to the level of insulation, enabling you to monitor new equipment that is to be installed at a rack level, adjust threshold values accordingly and distinguish leakage currents from real residual currents.



# A variety of plugs for international use

## Opening up international possibilities

In addition to the international standard connector systems of the IT industry – IEC60320 C13 and IEC60320 C19 – we offer you a wide range of country-specific connector systems based on our wide electrotechnical portfolio. Take advantage of what our PDUs offer you, no matter where your data centre is located.

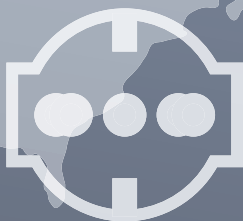

# Customising with the BACHMANN modular principle

Creating PDUs specially tailored to your needs

Whether home to just one rack or thousands every data centre has its own particular conditions that must be taken into account, especially when it comes to configuring the power supply. We are well aware that a professional and homogeneous data centre power supply requires PDUs that meet your needs, be that through a wide range of country-specific outlet ports, a variety of fuse protection options or supplementary elements providing modular surge protection or residual current monitoring, for example.

With the BlueNet series, we offer tailor-made units that extend far beyond the standard product range – even in small quantities. When used in conjunction with the BACHMANN modular system, this gives you incredible flexibility when configuring our PDUs – for optimum energy management in your data centre.



**BACHMANN PDU**  
**portfolio**





### **IT BASIC series**

IT PDU Basic 1U 19"

IT PDU Basic 1U vertical



### **BlueNet series**

BlueNet – smart solutions

BlueNet overview



# Power distribution units 230 – 400 V/50 Hz

## IT PDU Basic 1U 19"

With its IT PDU Basic 1 U 19", BACHMANN provides a huge choice of PDUs in a high-quality aluminium profile.

With their extremely compact design of just 1 height unit, 47mm in depth and 19" in width, the PDUs are a space-saving solution for integration into your IT rack.

Their multi-functional mounting brackets allow the units to be easily mounted in various ways (e.g. inwardly recessed). Our high quality standards ensure that the contact is reliable.

- ✓ Torsionally rigid 1 U aluminium profile
- ✓ Up to 12x IEC320 C13 socket inserts
- ✓ Universal fixing options
- ✓ Flexible positioning



# Power distribution units 230 – 400 V/50 Hz

## IT PDU Basic 1U vertical

For future-oriented, highly efficient power distribution in the data centre.

The high-quality and very robust aluminium profile measures a compact 44 x 47 mm. The space-saving design therefore provides room for data cabling and ventilation for cooling the server rack.

PDU with single or double infeed to increase performance or map redundancies, up to 96 A per PDU. Customised and country-specific series-quality solutions are available on request.

- ✓ Space-saving thanks to high packing density
- ✓ High-quality and very robust aluminium profile
- ✓ Phases identified by colour
- ✓ Double infeed possible



STATUS



MODBUS



LAN

USB



M1

M2

MODBUS



S1

S2

SENSOR



# The intelligent energy management system

## BlueNet – smart solutions

BlueNet offers a complete solution for structuring, controlling and monitoring IT power grids.

PDUs from the BlueNet series capture consumption and output data, and provide the user with relevant data and control options for modern energy management.

The BN3000 – BN7500 generation of our BlueNet products is synonymous with state-of-the-art technology – whether in the form of power distribution units (PDUs) that can be cascaded via Modbus, integrated, universal-current-sensitive residual current monitoring, command line tools or the rotating OLED display. And there's more: our features represent safety and efficiency, and they can be integrated into DCIM systems. From a single workplace, you can monitor and control your data centre's complex power grid locally or remotely.









**BlueNet**

Overview



Please turn page

# BlueNet overview

	PDUs for metering tasks	
	BN0500	BN2000
 Surge protection	(•)	(•)
 Measurement per phase	•	•
 Ethernet		•
 Sensors		•
 Modbus RTU/TCP		
 Type B RCM		
 Switching		
 Measurement per port		
 Powerline Communication		(•)

<p><b>Other features of the BN0500:</b></p> <p><b>Measurement:</b> Current, voltage, phase angle, frequency, effective power, energy meter, measuring accuracy 2%</p> <p><b>Display:</b> LCD</p> <p><b>Operation:</b> Local</p>	<p><b>Other features of the BN2000:</b></p> <p><b>Measurement:</b> Current, voltage, phase angle, frequency, effective power, reactive power, apparent power, energy meter, power factor, neutral conductor monitoring, measuring accuracy 1%</p> <p><b>Display:</b> TFT, display can be rotated using software</p> <p><b>Operation:</b> Web browser, local</p> <p><b>Connections:</b> 2 sockets for external sensors</p> <p><b>Communication:</b> IPv4, HTTP, DHCP, SNMPv2, SNMP Trap, Syslog, NTP</p>
---	---





PDUs for metering tasks		PDUs for switching and metering tasks	
BN3000	BN3500	BN7000	BN7500
(•)	(•)	(•)	(•)
•	•	•	•
•	•	•	•
•	•	•	•
•	•	•	•
(•)	(•)	(•)	(•)
		•	•
	•		•

**Other features of the BN3000–BN7500:**

**Measurement:** Current, voltage, frequency, effective power, reactive power, apparent power, energy meter, power factor, neutral conductor monitoring, measuring accuracy 1%

**Display:** OLED, display can be rotated using software

**Operation:** Web browser, local

**Connections:** USB, 2 sockets for external sensors, floating digital input, floating relay output

**Communication:** IPv4, IPv6, ModBus TCP, HTTP, HTTPS, SSH, DHCP, SMTP, SNMPv2, SNMPv3, SNMP Trap, Syslog, NTP, LDAP, JSON

(•) The indicated feature is available as an option.

# Technology modules



## **TECHNOLOGY MODULES**

Overview and benefits

High quality electrical engineering

PDUs: the central information  
and control element in the rack

# Technology modules

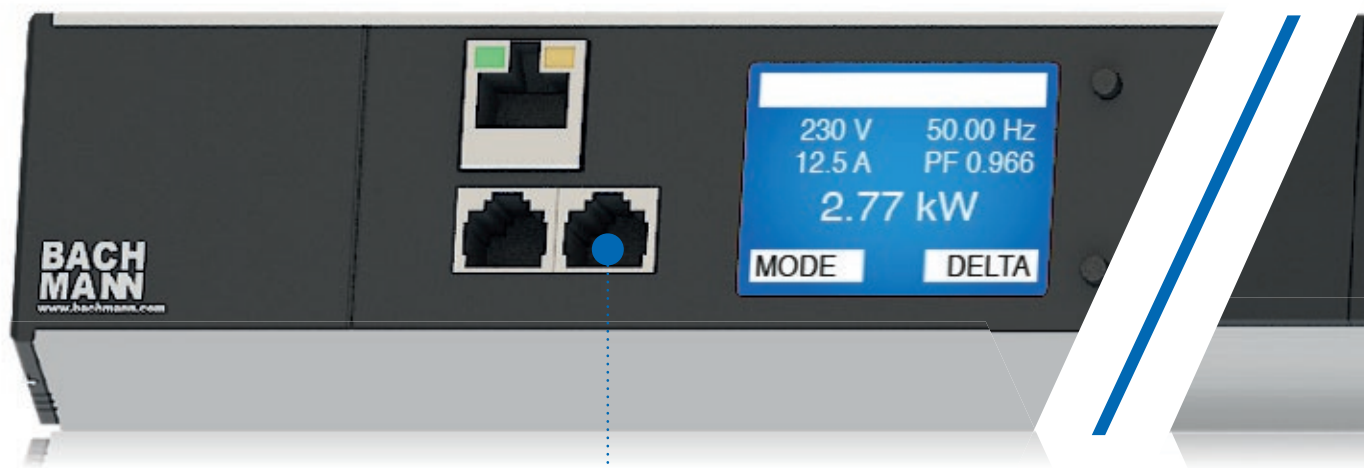

## Energy monitoring via the power grid

Decentralised IT infrastructures are no longer uncommon in large companies and network ports can often be very expensive in terms of maintenance and documentation. BACHMANN offers a real alternative here in the form of Powerline Communication (PLC), the solution that uses the existing power grid to transmit data. The PLC Concentrator allows you to keep an eye on all PLC components and transmit all data to the higher-level network via a central Ethernet interface.

**For more information on Powerline Communication (PLC), see page 42.**

## Detecting, locating and interpreting residual currents promptly

With integrated type B residual current monitoring (RCM), you are able to accurately assess the electrical condition of your data centre at any time. RCM sensors in accordance with EN 62020 enable you to distinguish leakage currents, which are physically induced, from real residual currents and to detect changes in the level of insulation at an early stage. Thus, you can plan countermeasures in good time, helping to safeguard the high availability of the power supply to your data centre.

**For more information on type B residual current monitoring (RCM), see page 36.**

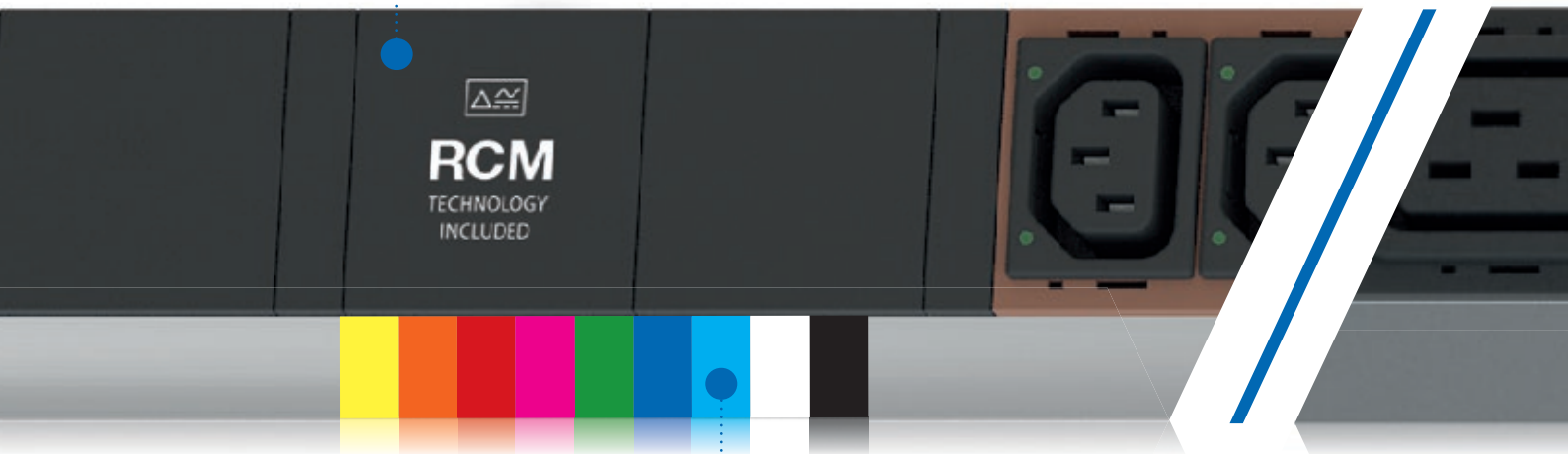

## Clearly identifying the A/B power supply

To quickly distinguish between PDUs and match them up easier in the rack, the BlueNet PDUs are available in different colours. Users can therefore quickly differentiate between the A and B supply during the installation phase or during service/maintenance work.

**For more information on colour coding, see page 40.**

## Data for optimising energy consumption

The optimum operation of a data centre is conditional on a granulated measurement of the temperature, air humidity and other operating states directly in the server rack. These requirements can be met using the BlueNet temperature sensor, the combination sensor (temperature/air humidity) and the GPIO Module.

**For more information on BlueNet sensors, see page 54.**



## Connecting external devices

The GPIO Module (GPIO: general purpose input/output) allows you to expand BlueNet BN3000 – BN7500 PDUs by adding external sensors and/or actuators. Floating contacts provided on-site can then be queried and evaluated, and signalling can be performed via internal relay contacts, for example creating a simple physical connection with the building control system. Furthermore, it enables a physical connection to be established with the building control system for issuing alarms in response to set threshold values, e.g. when the residual current is exceeded.

**For more information on the GPIO Module, see page 52.**

## Remote monitoring

In addition to the local display in every PDU, the BlueNet software via Ethernet Interface integrated in the PDU also gives you the means to monitor data at a central location from anywhere in the world, using standard browsers and the internet. We provide you with a corresponding MIB file (MIB: management information base) for implementing BlueNet PDUs in a higher-level monitoring or DCIM system (DCIM: data centre infrastructure management). So you can always keep an eye on your PDUs, as the smart strips deliver the latest status information in real time. You can then respond with automated actions via alarm chains defined in the BlueNet software or in your higher-level monitoring system.

**For more information on monitoring using BlueNet software, see page 48.**

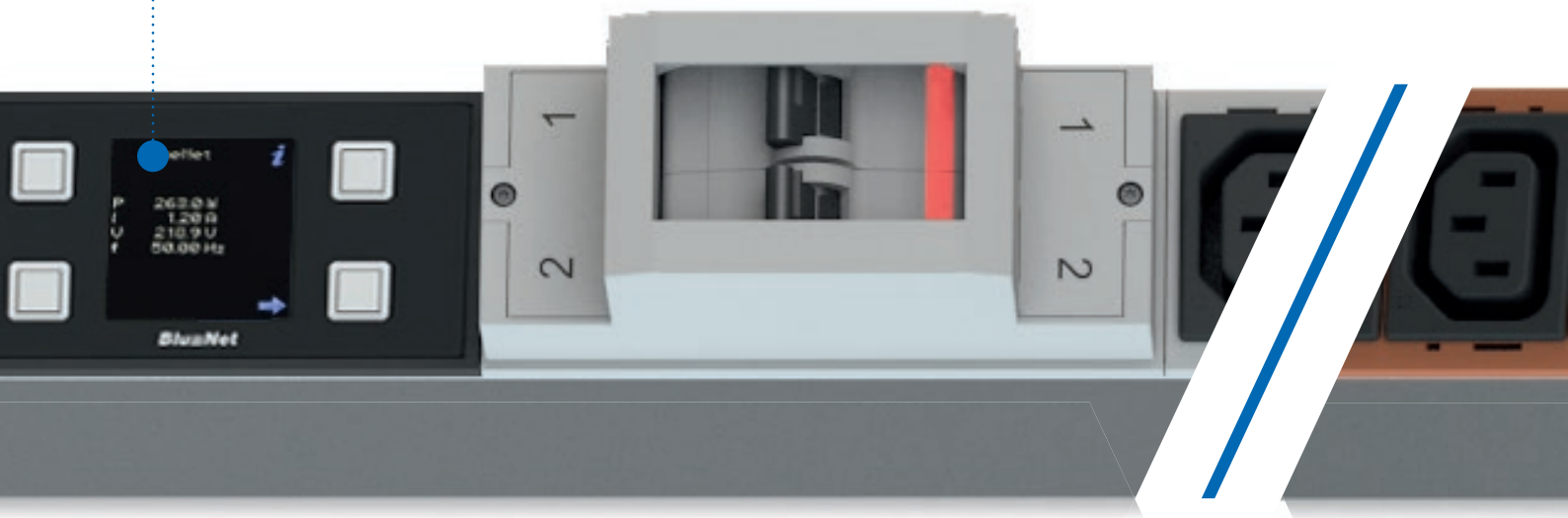
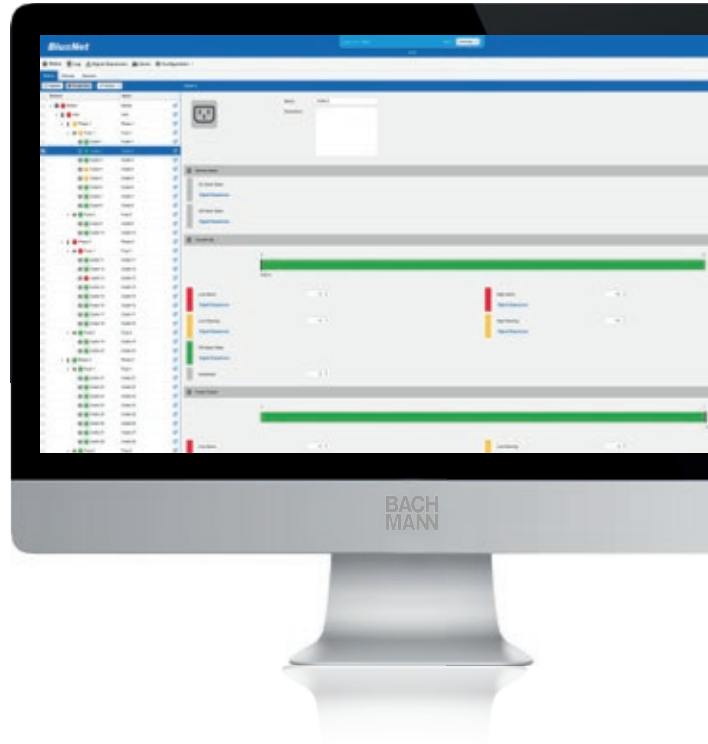

## Saving costs, minimising complexity

A BlueNet master PDU can manage up to 11 BlueNet slave PDUs via a separate Modbus connection. This means you can save on expensive network ports and are able to define groups of outlet ports that include several PDUs. Grouping in this way allows you to reset multiple power supply units of a server or switch at the same time.

**For more information on cascading using the master-slave concept, see page 50.**

## Preventing damage

The neutral conductor is very important in electrical systems, because its disconnection will either lead to an immediate and total failure or to high overvoltages/currents that can reach 1.73 times the nominal current of the outer conductor. All these risks call for the utmost care and attention – which is why neutral conductor monitoring is a requirement of EN 50600, the standard for data centres. Our BlueNet technology facilitates neutral conductor monitoring of the three-phase PDUs.

**For more information on neutral conductor monitoring, see page 34.**



## Improving profitability

Make optimum use of your resources with BlueNet: the transparency that BlueNet provides enables you to effectively measure, assess and optimise energy efficiency and costs, document peak loads and plan capacity more efficiently. A measurement is taken at each output, so BlueNet meets the requirements of granularity level 3 outlined in the data centre standard EN 50600.

**For more information on energy monitoring and management, see page 46.**



## Guaranteeing the safety of your applications

Increase the level of protection for your sensitive and expensive IT devices with our surge protection device. We offer a modular overvoltage concept that can be replaced during operation and that helps to protect your IT equipment from transient overvoltages resulting from atmospheric influences or switching processes – and which does so at rack level. By using this device, you will satisfy the requirements of IEC 60364-4-44 standards.

**For more information on surge protection, see page 38.**



**For more detailed information** on the technology modules and their benefits, read on.



Please turn page

## The TN-C-S system

The currents of the outer conductors (phase 1–3) flow back to the power source as a summation current via the neutral conductor (N). At a frequency of 50 Hz and a phase shift of 120°, this summation current is always zero.

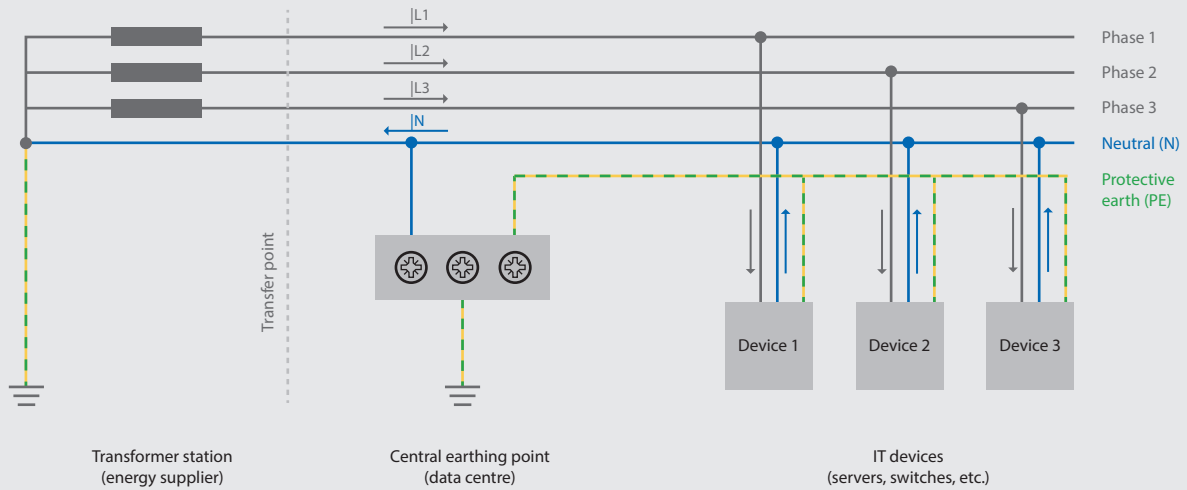

## Harmonic waves and their effects

Harmonic waves – triggered by the switching power supplies of the IT equipment – cause the frequencies to superimpose so unfavourably that there is an increased current flow at the neutral conductor (N).

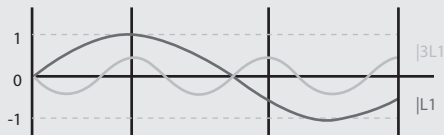

### Phase 1: currents in the outer conductor

$|L1|$  = fundamental component of current (50 Hz) = 100%  
 $|3L1|$  = current of the third harmonic (150 Hz), e.g. 45%

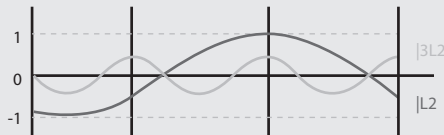

### Phase 2: currents in the outer conductor

$|L2|$  = fundamental component of current (50 Hz) with a phase shift of  $-120^\circ$  = 100%  
 $|3L2| \hat{=} |L3L1$  150 Hz, no phase shift), e.g. 45%

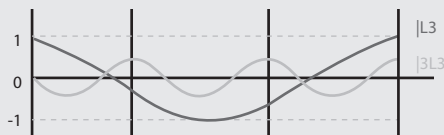

### Phase 3: currents in the outer conductor

$|L3|$  = fundamental component of current (50 Hz) with a phase shift of  $+120^\circ$  = 100%  
 $|3L3| \hat{=} |L3L2$  (150 Hz, no phase shift), e.g. 45%

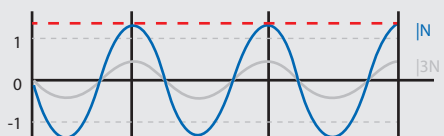

### Currents in the N conductor

$|N|$  = fundamental component of current = 0%  
 $|3N|$  = current of the third harmonic =  $|3L1| + |3L2| + |3L3| = 135\%$

# Preventing damage

## Neutral conductor monitoring

Generally speaking, operators of data centres want to achieve almost symmetrical utilisation of the outer conductors (phases), although this is not always possible. On top of this, the multitude of switching power supplies in the connected IT devices generate an unpleasant side effect in the form of unwanted harmonic waves, which superimpose the 50 Hz fundamental frequency in the grid.

The superimposed harmonics mean there is no longer a value of “zero” at the neutral conductor; rather, in the worst-case scenario there will be a much higher value, which can even reach 1.73 times the nominal current of the outer conductors. It is essential for this huge current load to be monitored, which our BlueNet PDUs do with additional built-in sensors.

There is another factor that makes neutral conductor monitoring necessary: improper installations may result in the neutral conductor being connected incorrectly or loosely within the installation. Depending on the internal resistances of the connected IT equipment, this could lead to extreme overvoltages and, consequently, to the IT devices being seriously damaged or even destroyed. This is another reason why neutral conductor monitoring is so important.

All of the above means that neutral conductor monitoring is a requirement of EN 50600, the standard for data centres. BACHMANN's three-phase BlueNet PDUs from series BN3000–BN7500 can be equipped with this function, which will be beneficial when certifying your data centre in accordance with EN 50600.

- ✓ Simple monitoring of excessive current loads
- ✓ Prevention of IT equipment being damaged/destroyed by overvoltage
- ✓ Fulfilment of data centre standard EN 50600

## RCM system with visual and audible alarm

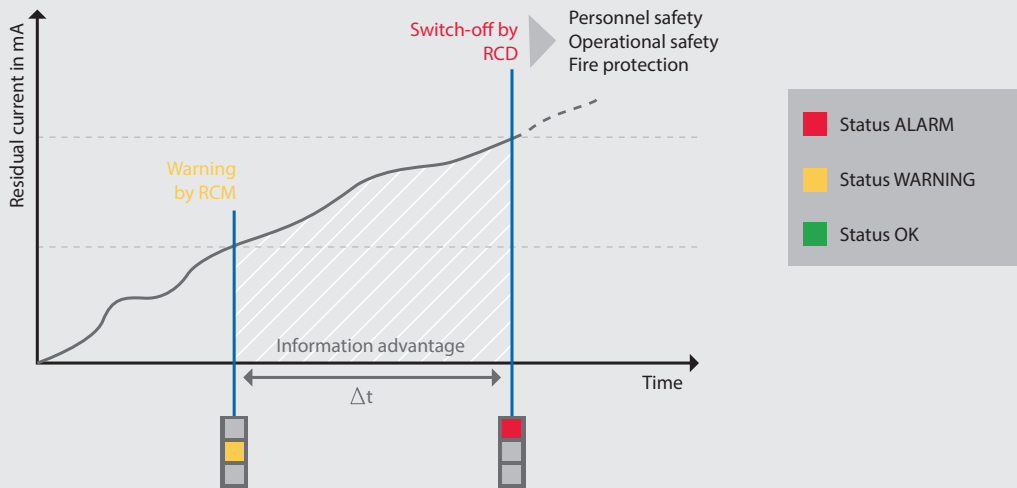

## Positioning RCM sensors correctly

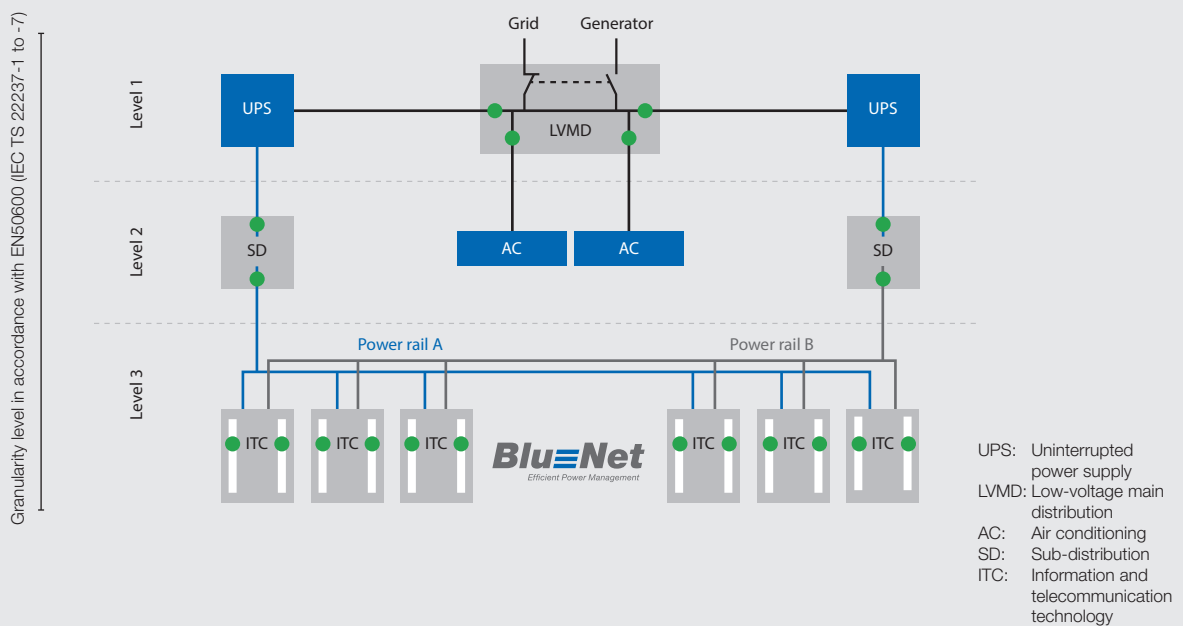

# Detecting, locating and interpreting residual currents promptly

## Type B residual current monitoring (RCM)

Using type B residual current monitoring (RCM) allows changes in the level of insulation of your power supply to be detected promptly, before protective devices are tripped by a residual current that puts people at risk and involves the risk of fire, which would lead to the failure of critical IT infrastructure. This time advantage allows countermeasures to be planned and contributes to the high availability of the power supply and, therefore, the data centre.

Thanks to our BlueNet PDU, this residual current monitoring is not just undertaken at central measuring points in the main distribution or sub-distribution, but granulated at rack level in every PDU and even for every phase. In the event of escalation, this will help to locate the sources of errors faster and rectify them efficiently.

The residual current sensor conforms to EN 62020 and provides a high physical granularity, maximum safety and high availability. This AC/DC-sensitive technology (type B) monitors all kinds of residual current and enables the user to differentiate between alternating (AC) and direct (DC) residual currents. Leakage currents, which are physically required, can therefore be distinguished from real residual currents. Both measured values (AC and DC) are evaluated separately via BlueNet software and made available to the monitoring system or the building control system. This kind of residual current monitoring (type B RCM) is therefore particularly suited to use in IT.

- ✓ Greater safety for people, operations and systems
- ✓ Retests require less effort
- ✓ Greater fire protection
- ✓ More cost-effective



### Modular surge protection – can be replaced during operation

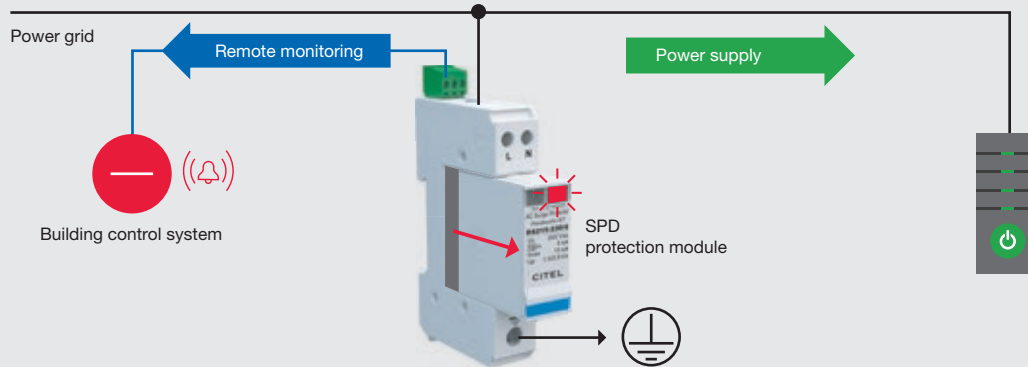
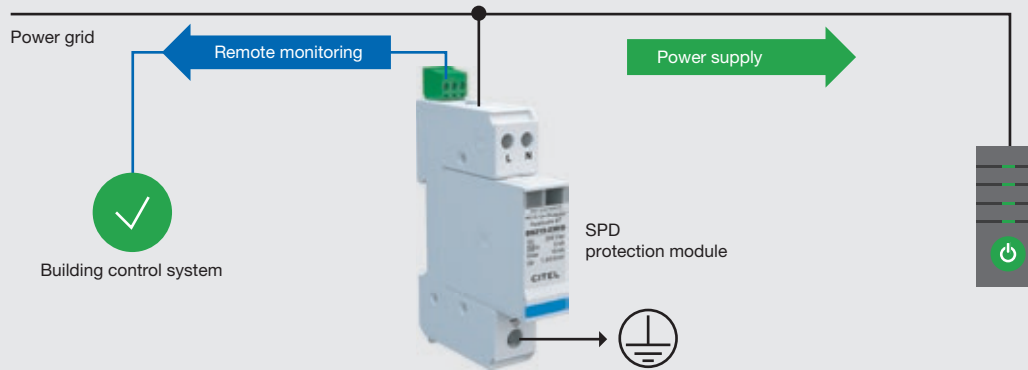

# Guaranteeing the safety of your applications

## Surge protection device (SPD)

Standards DIN VDE 0100-443 and IEC 60364-4-44 stipulate that a surge protection concept is a fundamental component of any new building, including new data centres that are going to be built. The effective protection zone of an SPD (surge protection device) is taken into consideration in the standards DIN VDE 0100-534 and IEC 60364-4-44 for the first time, with a maximum zone of 10 m. If this maximum distance cannot be met, then additional overvoltage protection (type 3) should be installed as close to the protected device as possible. The experts here at BACHMANN recommend installation in the PDU, directly on the devices.

Once the data centre has been built and put into operation, another challenge raises its head: what happens if the surge protection device has been triggered by atmospheric influences or a switching process?

Our BlueNet series PDUs, with their standard-compliant and, above all, modular overvoltage concept provide important assistance at this point. The type 3 SPD protection modules can be replaced tool-free during operation, so the power supply will no longer have to be interrupted if the device is tripped or needs to be changed. This method is a much cheaper way of restoring the function of the surge protection device. In addition, the protection status of the arrester module is monitored by the PDU, visualised in the BlueNet software and an alarm can be issued as a signal sequence via various communication interfaces.

- ✓ Can be replaced tool-free and during operation
- ✓ Shock-hazard-protected base unit
- ✓ Lower costs for restoring the SPD





# Clearly identifying the A/B power supply

## Colour coding

The availability of any data centre is based on various redundancy concepts, which usually feature a two-fold power supply for all IT components at rack level. To quickly distinguish between PDUs and match them up easier in the rack, the BlueNet PDUs are available in different colours. Users can therefore quickly differentiate between the A and B supply during the installation phase or during service/maintenance work. Different application or customer areas in the data centre (known as cages) can also be equipped with differently coloured PDUs.

Clear colour coding also makes installation and mounting easier. Easy-to-mount accessories that enable the PDU to be positioned at all rack levels complete the overall BACHMANN package.

- ✓ Faster differentiation, easier matching of PDUs in the rack
- ✓ Different colours for cages in the data centre
- ✓ Simpler installation and mounting

# The power grid becomes a network

BN2000  
PLC PDUs

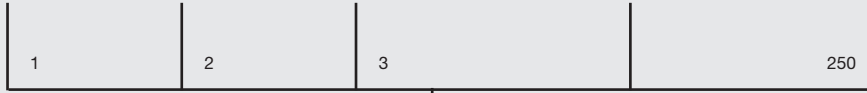

Power grid

PLC  
Concentrator



Ethernet 10/100 Mbps



# Energy monitoring via the power grid

## Powerline Communication (PLC)

Reducing running costs in data centres is one of the most challenging tasks faced when planning and operating a data centre or a decentralised infrastructure. The BlueNet PDUs from series BN2000 can really help to bring down the costs of the requisite network infrastructure, whilst still providing all the relevant measured data at rack level.

The BlueNet PLC Concentrator is at the heart of this innovative monitoring concept. On the one hand, it acts as a data collector for all the PLC units within the network and, on the other, as an interface with the higher-level Ethernet network. HTTPS, HTTP, SMTP, SNMP and SNMP trap are just some of the network protocols available. Up to 250 PLC units (PDUs) can be monitored as standard with one Concentrator, i.e. with just one IP address.

PLC technology offers industry-compatible narrowband communication in the frequency range 95 to 125 kHz in accordance with international standard CENELEC B for Europe. Other standards, such as FCC (155 to 487 kHz) for the USA and other regions around the world, can be selected via a software setting. The range between two PLC units may be up to 250m. PLC technology is suitable for our BlueNet PDUs from series BN2000. Measurements are taken for each phase at the input of the PDU. The measured values of every PDU are also shown locally on the TFT display.

- ✓ Reduction in running costs
- ✓ Communication based on national and international standards
- ✓ Integrated energy management cockpit
- ✓ Measurement per phase

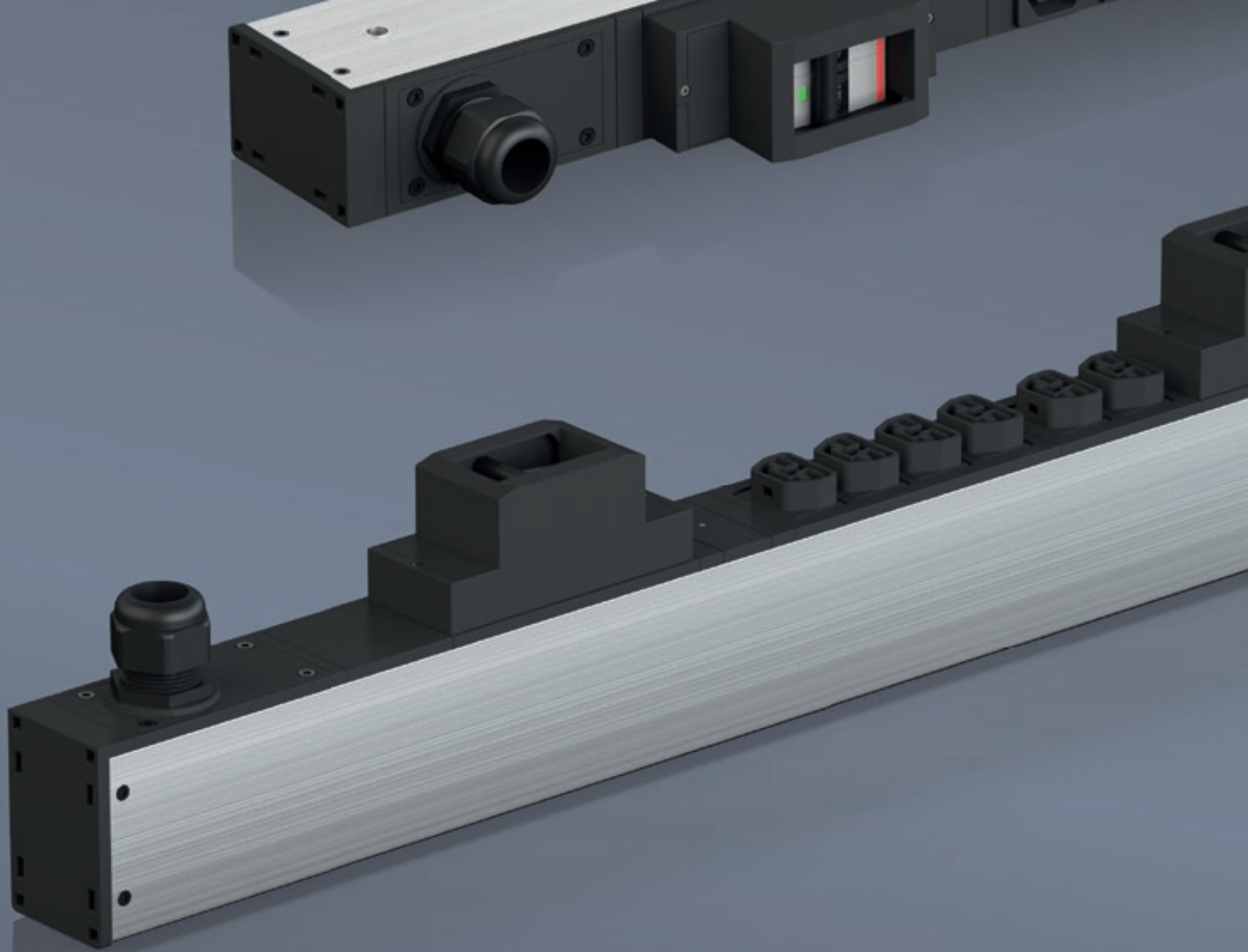

## Power distribution in data centres based on renewable energies and the use of 380 V DC voltage

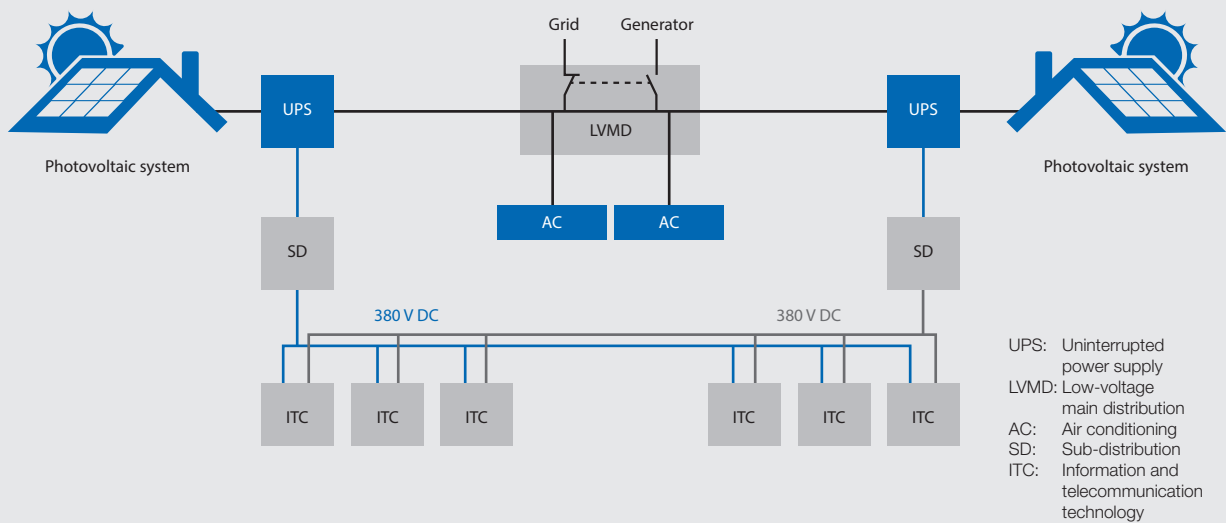



# Integration of renewable energies in the data centre

## 380 VDC PDUs

Due to their power density, data centres rank alongside heavy industry as a large-scale consumer of electrical energy. It is therefore essential to save energy and use renewable energies.

In order to make efficient use of renewable energies, one must consider the entire energy chain in the data centre, from the grid operator to various distributions and all the way through to the devices. One promising solution here is the extensive use of 380 VDC voltage, since photovoltaic systems, energy stores and IT devices can all be operated with a DC voltage. Modern power electronics now offer numerous ways of converting direct current (DC) with virtually no losses, making the process of transmitting and transforming energy much more efficient. Just one of the benefits of this method is that the photovoltaic energy generated can be fed into the DC link by UPS systems provided specifically for that purpose and used directly.

Endless conversion chains from AC to DC and vice versa can therefore be eliminated, saving costs amounting to 5–10% of a data centre's total energy requirements.

As a driver of innovation, we have set ourselves the goal of helping to shape this shift to more energy-efficient data centres. We are actively participating in the DKE/VDE and IEC standardisation committees to establish direct current as the technology of the future for supplying power in data centres. At the same time, we are currently looking into the options for creating a PDU series based on 380 VDC.

- ✓ Improving energy efficiency by reducing AC/DC conversion losses
- ✓ Increasing efficiency when transmitting energy
- ✓ Supporting more environmentally friendly power generation through renewable energies



# Improving profitability

## Energy monitoring and management

Make optimum use of your resources with BlueNet: the transparency that BlueNet provides enables you to effectively measure, assess and optimise energy efficiency and costs, document peak loads and plan capacity more efficiently. A measurement is taken at each output, so BlueNet meets the requirements of granularity level 3 outlined in the data centre standard EN 50600.

The high sensor measuring accuracy of  $\pm 1\%$  is an important quality feature of the BlueNet series. You can take measurements for each phase at the input of every PDU or for each output port (BlueNet BN3500 + BN7500), depending on your requirements. Thanks to this measuring accuracy, you will not only be able to optimise your data centre's energy costs, but also to pass them on for a specific application or customer with  $\pm 1\%$  billing accuracy.

- ✓ Effectively measuring, assessing and optimising energy efficiency and costs
- ✓ More efficient capacity planning
- ✓ High measuring accuracy for  $\pm 1\%$  billing accuracy

Table with columns: Name, IP, Port, Protocol, Size, Address, Version, Operating, Architecture, Platform, Security, Remarks, Date/Time, Source/Target, Priority. The table contains multiple rows representing network configurations or logs, with various colored bars (green, yellow, red) in the 'Port' column.





# Remote monitoring

## Monitoring with BlueNet software

In addition to the local display in every PDU, the BlueNet software via Ethernet Interface integrated in the PDU also gives you the means to monitor data at a central location from anywhere in the world, using standard browsers and the internet. We provide you with a corresponding MIB file (MIB: management information base) for implementing BlueNet PDUs in a higher-level monitoring or DCIM system (DCIM: data centre infrastructure management). So you can always keep an eye on your PDUs, as the smart PDUs deliver the latest status information in real time. You can then respond easily and immediately with automated actions via the DCIM system.

Communication is encrypted and complies with the applicable security standards, enabling you to make any settings for threshold values, network parameters or alerts. For example, if a particular threshold value is reached, an alert can be e-mailed to the responsible employee's smartphone so appropriate measures can be taken straightaway if necessary. In addition, control via the command line interface or SNMP is also possible, in order to connect to existing or higher-level systems.

Access rights to the PDU can be defined on a user-specific basis and restricted to read-only data access, for example. Only the administrator has full read and write access. The administrator can create other users and define their rights at the PDU level.

- ✓ The latest status information in real time
- ✓ Automatic alerts, e.g. in the form of e-mails
- ✓ Connection to existing or higher-level systems



# Saving costs, minimising complexity

## Cascading using the master-slave concept

A BlueNet master PDU can manage up to 11 BlueNet slave PDUs via a separate Modbus connection. This means you can save on expensive network ports and are able to define groups of outlet ports that include several PDUs. Grouping in this way allows you to reset multiple power supply units of a server or switch at the same time.

Every BlueNet PDU features Modbus RTU interfaces to facilitate cascading. The PDUs are connected to one another via a standard network cable – there is no need for any special cables. With this type of cascading, you will only need to provide one network port for a total of six racks with two BlueNet PDUs each, for example. This makes the communication network less complex and reduces the number of IP addresses required.

The PDUs from series BN7000 and BN7500 are PoE-capable (PoE: Power over Ethernet), i.e. if you were to use a PoE switch, it would still be possible to assess the status of the PDUs and the sensors even if the power were to fail.

- ✓ Saving on expensive network ports
- ✓ Reduction in the number of IP addresses required
- ✓ No special cables necessary



### Sensor extension via GPIO Module

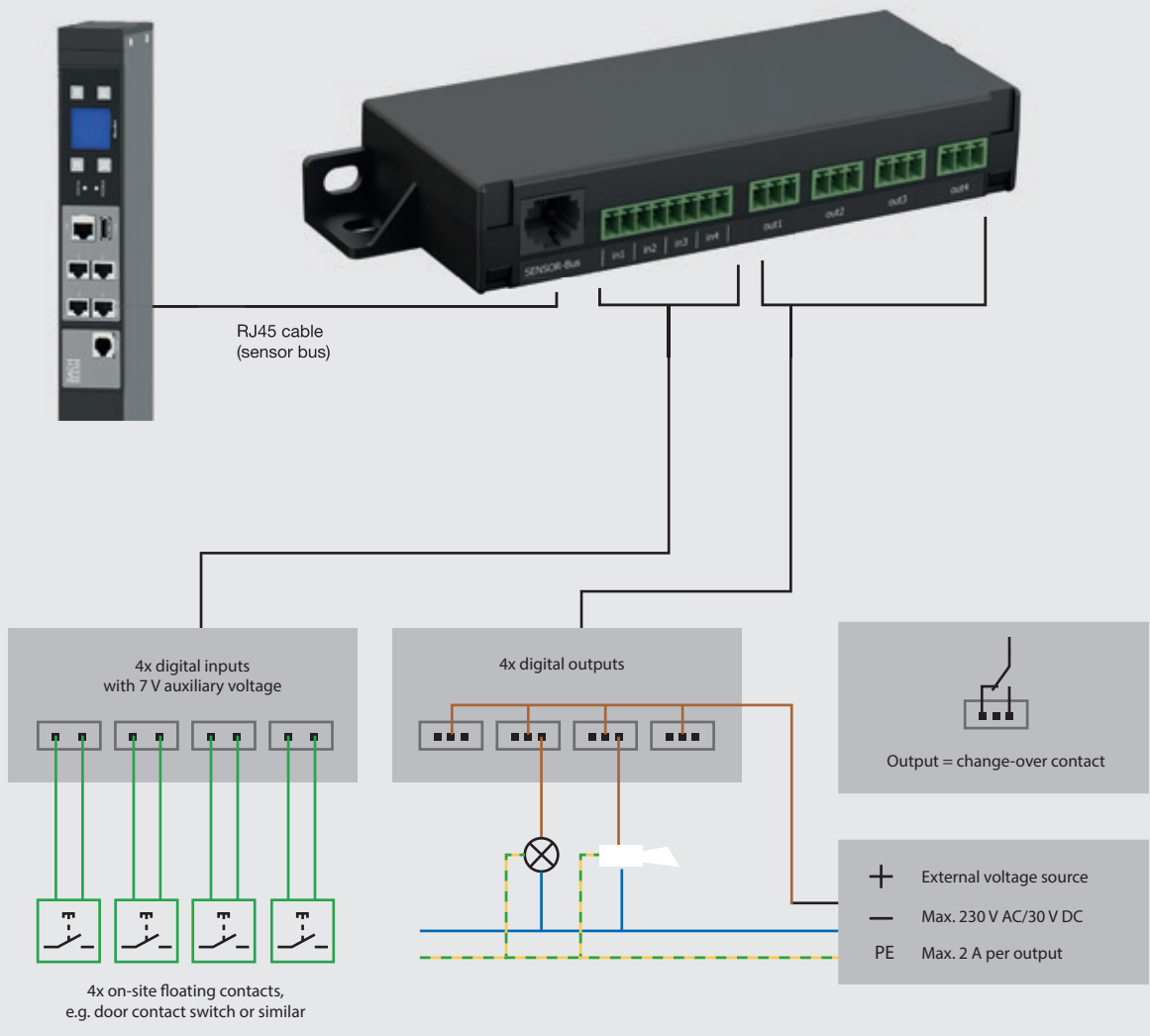

# Connecting external devices

## GPIO Module

The GPIO Module (GPIO: general purpose input/output) allows you to expand BlueNet BN3000–BN7500 PDUs by adding external sensors and/or actuators. Floating contacts provided on-site can then be queried and evaluated, and signalling can be performed via internal relay contacts, for example. Furthermore, it enables a physical connection to be established with the building control system for issuing alarms in response to set threshold values, such as when the residual current is exceeded.

The GPIO Module features four programmable inputs and four programmable outputs that are visualised in the BlueNet BN3000 – BN7500 software user interface. The PDU in the server rack is therefore evolving into a central, intelligent control unit for all physical parameters.

The input contacts provide an auxiliary voltage of 7V and can be assigned to signal sequences. The floating output contacts can be controlled automatically by signal sequences or manually via the software user interface. Bi-stable relays enable loads of up to 2 A/230VAC or 2 A/30VDC to be switched.

The GPIO Module is connected to one of the two sensor ports of the BlueNet BN3000 – BN7500 PDUs via a standard network cable. There is no need for an external voltage supply to operate the GPIO Module.

- ✓ Simple monitoring and signalling
- ✓ Inputs and outputs can be visualised in the software user interface
- ✓ Configuration via BlueNet software
- ✓ Simple to install



BlueNet

P  
I  
U  
t

263.0 W  
1.20 A  
218.9 V  
50.00 Hz

BlueNet

RCM  
TECHNOLOGY  
INCLUDED

BlueNet  
802.0101

BlueNet  
802.0102

# Data for optimising energy consumption

## BlueNet sensors

The optimum operation of a data centre is conditional on a granulated measurement of the temperature, air humidity and other operating states directly in the server rack. These requirements can be met using the BlueNet temperature sensor, the combination sensor (temperature/air humidity) and the GPIO Module.

The sensors and/or the GPIO Module are connected to the sensor ports of the BlueNet PDU using Plug & Play and monitored continuously. If values exceed or fall below configurable threshold values, this is detected and signalled at an early stage. In this way, we are helping to ensure the air conditioning runs efficiently in your data centre, while improving operating conditions for your IT equipment at the same time.

The availability of the data centre as a whole can thus be guaranteed, any loss of data caused by sudden interruptions to operation can be avoided and the energy footprint can be optimised.

- ✓ Easy measurement of temperature, air humidity, etc.
- ✓ Permanent monitoring
- ✓ Data centre availability guaranteed

# The BACHMANN Group

Innovative, individual,  
international

BACHMANN, founded in 1947, is an owner-managed company with a global presence in the electrical engineering sector. Based in Stuttgart, the BACHMANN Group develops, produces and markets innovative electrical components and systems such as intelligent power distribution units, desk connection panels and assemblies.

70 years of experience in developing, manufacturing and distributing power distribution solutions: true to this history, BACHMANN is synonymous with high-quality and innovative electronics and high measuring accuracy, packaged in extremely robust aluminium housings. We provide solutions in IT power distribution. Our intelligent and modular product range guarantees maximum safety.



**WE  
power  
YOUR LIFE.**

**IT power  
distribution**

**BACH  
MANN**



**BlueNet**  
*Efficient Power Management*

**70** years of  
experience

in developing, manufacturing  
and distributing high-quality  
power distribution solutions

Over **2,000**  
standard products

BASED IN  
  
STUTT GART

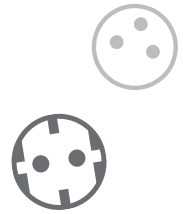

**POWER DISTRIBUTION UNITS**

  
**1947**  
established

**RELIABLE  
SAFETY**



Residual current monitoring

AROUND  
**800**  
EMPLOYEES  
WORLDWIDE

AROUND  
**30**  
TRADING PARTNERS  
WORLDWIDE

PROVIDING  
**LIFE**  
QUALITY

BlueNet series  
**BN3000 – BN7500**







 **Bachmann GmbH**  
Ernstthalenstr. 33  
70565 Stuttgart | Germany

 +49 711 86602-0

 +49 711 86602-34

 [info@bachmann.com](mailto:info@bachmann.com)

 [www.bachmann.com](http://www.bachmann.com)